

5-PCS-1 10

5-PCS-2 10

valve type with pilot valve

lateral valve

type PCS-1 10 PCS-2 10

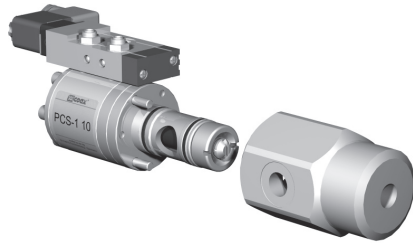

2/2 way valve externally controlled
pressure range PN 0-200 bar
orifice DN 10 mm
connection thread/cartridge
function valve normally closed symbol **NC**
 valve normally open symbol **NO**

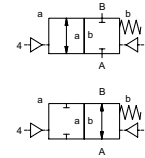

△ Above stated body materials refer to the valve port connections that get in contact with the media only!

design pressure balanced, with spring return
body materials ① aluminium ③
 ① ④
 ② ⑥ stainless steel
valve seat synthetic resin on metal metal on metal
seal materials HNBR FPM, EPDM

details needed for main valve

- orifice
- port
- function NC/NO
- operating pressure/Δp
- flow rate
- media
- media temperature
- ambient temperature
- type of actuation

details needed for pneumatic actuation

- nominal voltage
- type of protection
- actuation pressure range min/max
- low wattage coil, actuation pressure range 4-7 bar
- pilot valve type

details needed for hydraulic actuation

- actuation pressure range min/max
- hydraulic control valve function

general specifications

ports	PCS-1 without valve body	with valve body thread G 3/8
	PCS-2 without valve body	with valve body thread G 3/8
function	NC	NO
pressure range	bar 0-200 (see pressure diagram)	NO (see pressure-diagram)
Kv value	m ³ /h 3,0	
vacuum	leak rate	
pressure-vacuum	P ₁ ↔ P ₂	
back pressure	P ₂ > P ₁	available upon request
media	gaseous - liquid - highly viscous - gelatinous - pasty - contaminated	
abrasive media		version available
damping	opening by throttles on pilot valve	
flow direction	A ↔ B as marked	bi-directional upon request
switching cycles	1/min 700	
switching time	ms opening 30-3000 closing 30-3000	
media temperature	°C direct mounted pilot valve 60	remote mounted pilot valve outside temperature range of media max.150°C
ambient temperature	°C direct mounted pilot valve 50	
flush ports		available
leak ports		inductive
limit switches		
manual override	via 5/2-way pilot valve	
approvals		WAZ
mounting		mounting holes on valve body 2 x M6
weight	kg PCS-1 1,1 PCS-2 1,2	PCS-1 1,7 PCS-2 1,8
additional equipment		valve body

electrical specifications

nominal voltage	U _n DC 24V	special voltage upon request
	U _n AC 230V 50 Hz	special voltage upon request
power consumption	DC 4,8 W	2,5 W
	AC pick up 11,0 VA holding 8,5 VA	
protection	IP 65 (P54) acc. DIN 40 050	
energized duty rating	ED 100%	
connection	plug acc. DIN EN 175301-803 form B, 4 positions x 90° / wire diameter 6-8 mm	
additional equipment	illuminated plug with varistor	connector acc. VDMA
optional	M12x1 connector acc. DESINA	
max. temperature	media 60°C	
	ambient 50°C	
explosion proof	EEx m II T5 nominal voltage U _n	direct current 24 V 3,25 W
	power consumption	alternating current 230 V 50 Hz 2,90 W

pneumatic specifications

actuation pressure range	bar 4-10	
air consumption	cm ³ /stroke PCS-1 7 PCS-2 17	
cycle speed	main valve speed variable by throttles on pilot valve	
control	by 5/2-way pilot valve	
actuator ports	2/4 G 1/8	

hydraulic specifications

actuation pressure range	bar 10-30	>30 bar upon request
by media		
control	preferably 4/2-way control valve	
actuator ports	XY G 1/4 via adapter	NPT 1/4 via adapter

⚠ The valves' technical design is based on media and application requirements. This can lead to deviations from the general specifications shown on the data sheet with regards to the design, sealing materials and characteristics.

⚠ If order or application specifications are incomplete or imprecise there exists a risk of an incorrect technical design of the valve for the required application. As a consequence, the physical and / or chemical properties of the materials or seals used, may not be suitable for the intended application.

■ specifications not highlighted are standard
 ■ specifications highlighted in grey are optional

type PCS-1 10

function: **NC**
closed when not energized

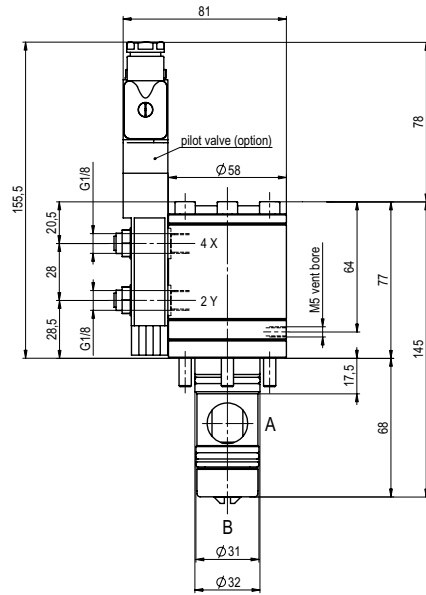

drilling design for cartridge

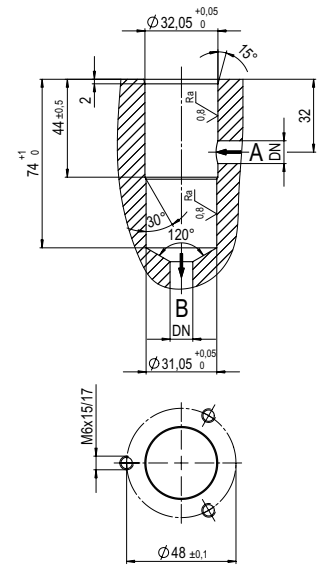

type PCS-2 10

function: **NO**
open when not energized

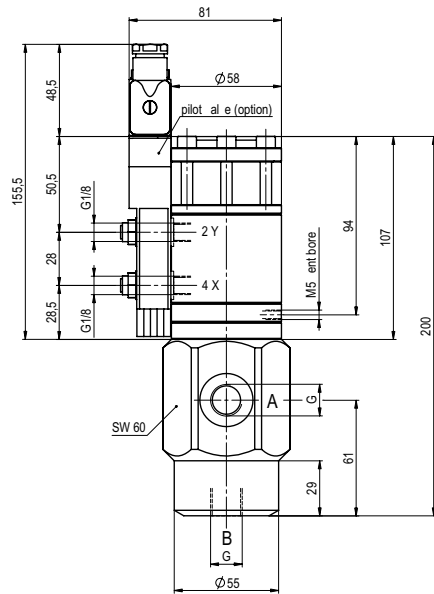

pneumatic actuation (separately)

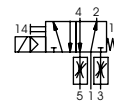

5/2-way-pilot valve
flow rate 350 l/min
pressure range 3-10 bar G 1/8

pressure-diagram

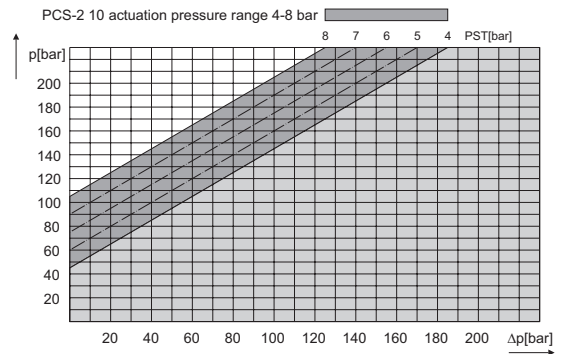
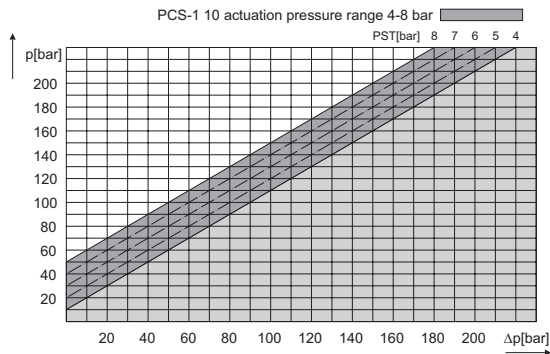

The application-specific layout relating to temperature, pressure conditions, switching behavior, media and its consistency may restrict the range of use or necessitate relevant modifications to materials used and seal arrangements.

Rights reserved to make technical alterations • Not responsible for printing errors • Detailed drawings can be obtained upon request