

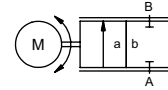

positioning valve

type **RMQ 32**



control valve electro motorically controlled
pressure range PN 0-64 bar
orifice DN 32 mm
connection thread
function stepless
 stroke regulation



 Above stated body materials refer to the valve port connections that get in contact with the media only!

design direct acting with integrated 3-point-regulation
body materials ① brass ④
 ② ⑤
 ③ ⑥ stainless steel
valve seat synthetic resin on metal
seal materials FPM, PTFE

details needed

- orifice
- port
- operating pressure/Δp
- flow rate
- media
- media temperature
- ambient temperature
- nominal voltage
- control signal

	general specifications	options
ports	RMQ threads G 1 1/4 - 1 1/2	
function	stepless regulation	
pressure range	bar 0-16 0-64	
Kv value	DN 32	
	m³/h 0-20,0	
back pressure	bar max. 10	
media	gaseous - liquid - highly viscous - contaminated	
abrasive media		version available
flow direction	A ⇨ B as marked	
switching cycles		
operating time	DN 32	
closed - open	sec. ca. 3,5	
media temperature	°C -20 to +80	
ambient temperature	°C max. +70	
approvals		WAZ
mounting		mounting bracket
weight	kg RMQ 8,6	

	electrical specifications	options
nominal voltage	U _n 24 V DC	
	U _n 24 V AC	
power consumption	DC < 0,5 A	
	AC < 0,5 A	
control signals	I _e 0-20 mA / 4-20 mA	actual valve output
	U _E 0-10 V	I _x 4-20 mA
protection	IP 65 (P54) acc. DIN 40 050	
energized duty rating	ED 100%	
connection	M12x1 concentric socket DIN 40040, 5 poles / wire diameter 6-8 mm	
additional equipment	internal separate actual value output	

 The valves' technical design is based on media and application requirements. This can lead to deviations from the general specifications shown on the data sheet with regards to the design, sealing materials and characteristics.

 If order or application specifications are incomplete or imprecise there exists a risk of an incorrect technical design of the valve for the required application. As a consequence, the physical and / or chemical properties of the materials or seals used, may not be suitable for the intended application.

■ specifications not highlighted are standard
 ■ specifications highlighted in grey are optional

type RMQ 32

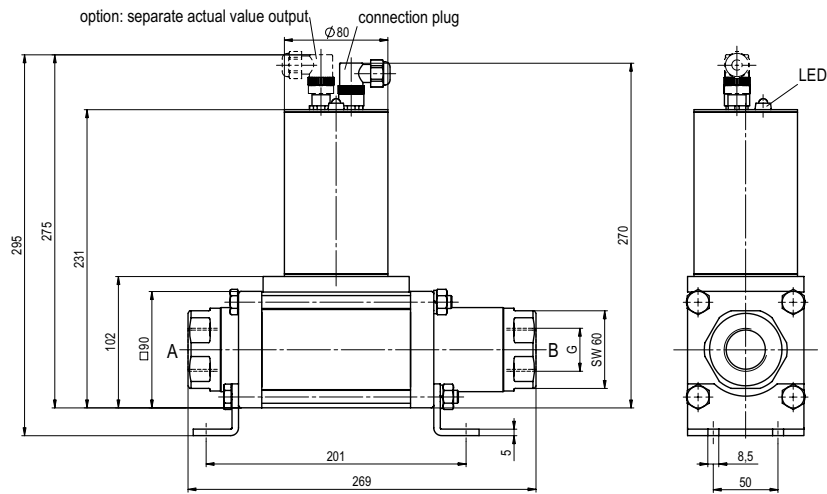

kv-value

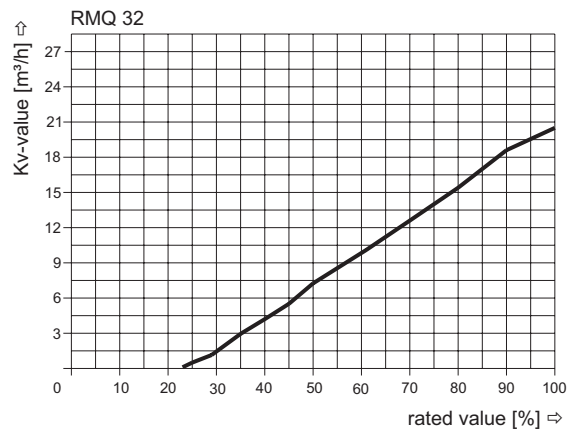

connection plan / connection plug

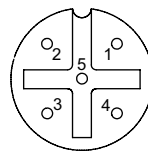

- 1: nominal voltage
- 2: nominal voltage
- 3: control signal
- 4: ground (control signal)
- 5: ⊕

option separate actual value output

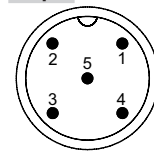

- 1: actual value 4-20 mA (+)
- 2: actual value 4-20 mA (-)